

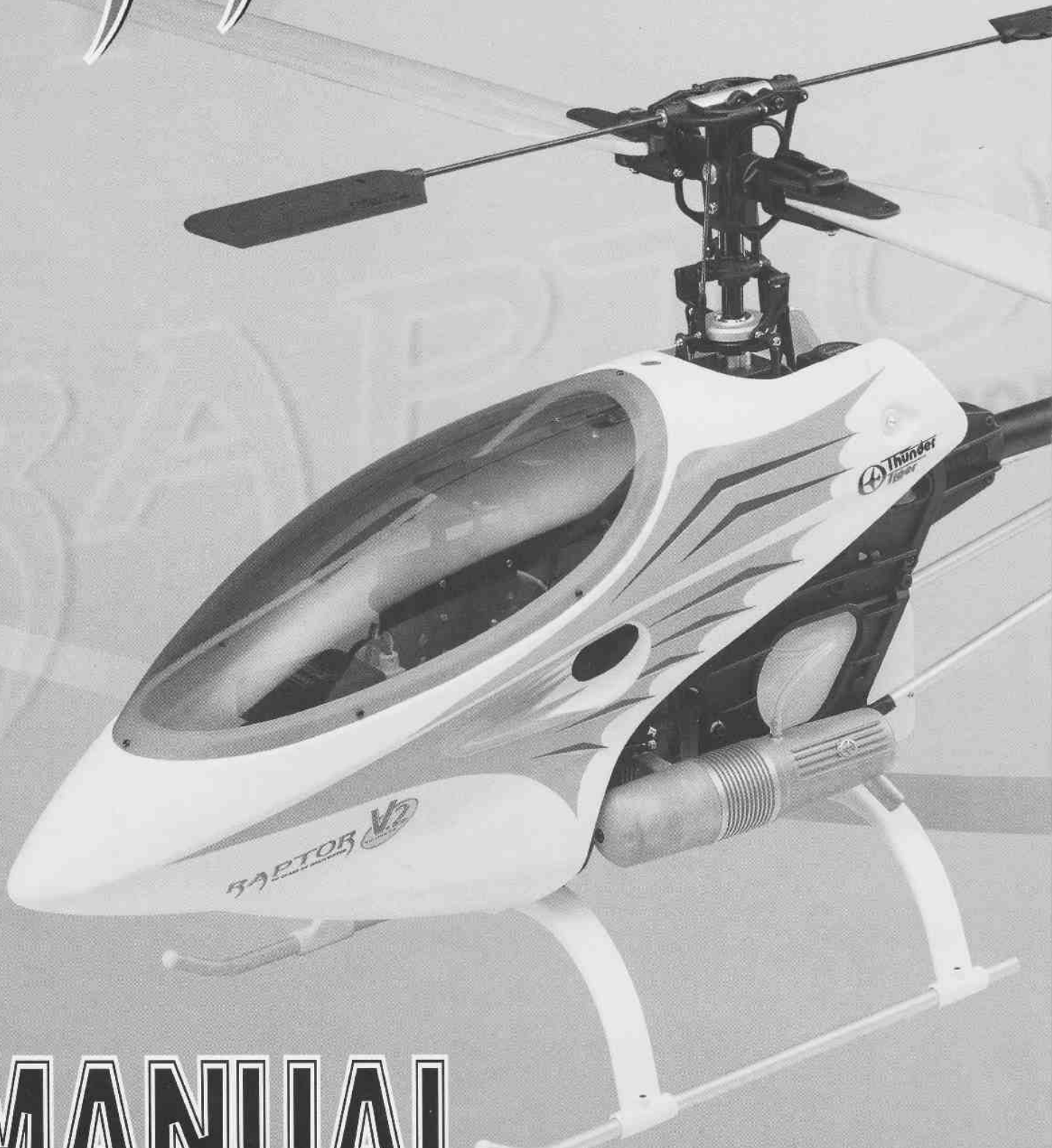

RAPTOR

30 CLASS RC HELICOPTER



MANUAL

Montage & Bedienungsanleitung

Thunder Tiger Deutschland GmbH - Ulmer Landstr. 249 - D-86391 Stadtbergen

www.thundertiger.de

TEILELISTE

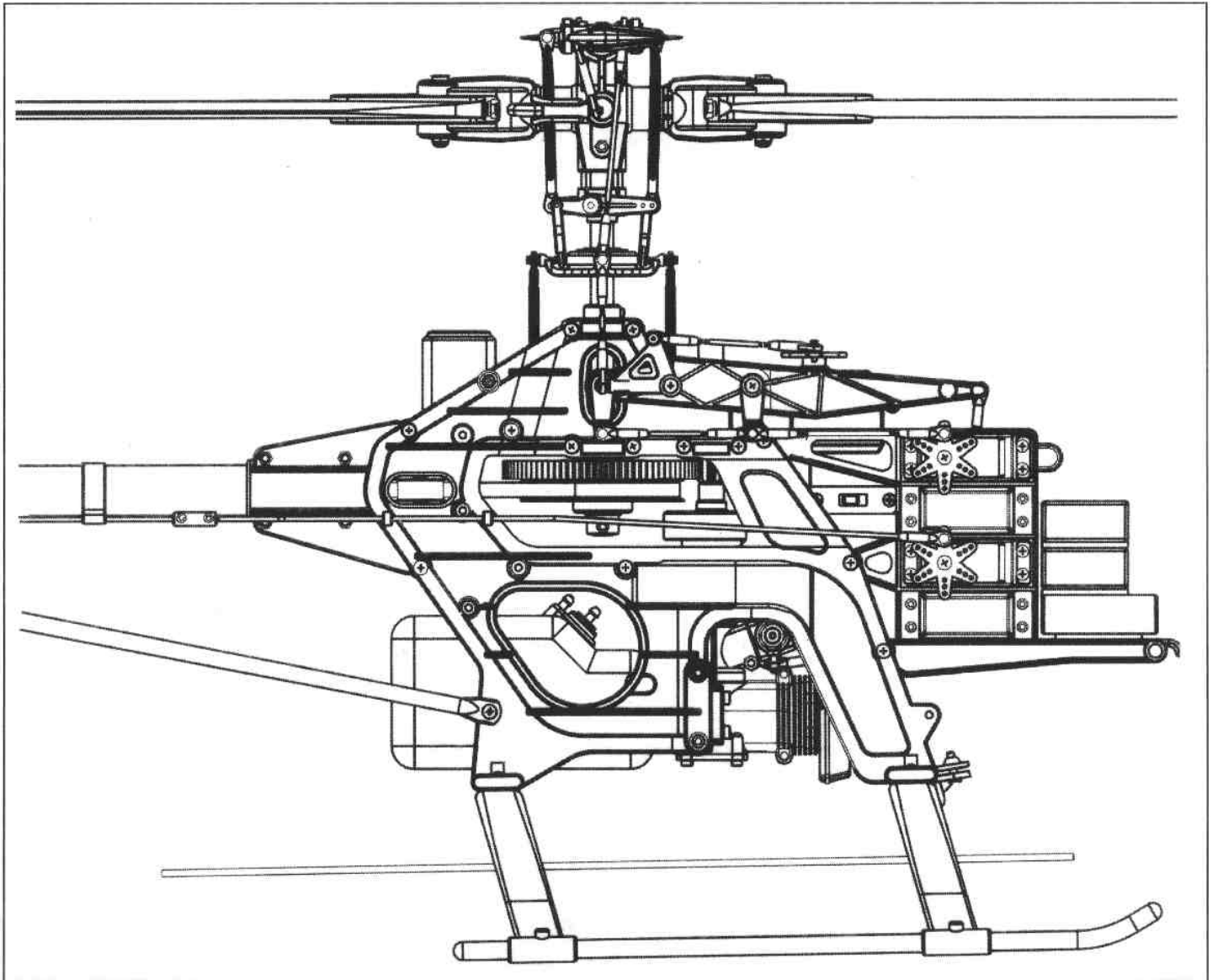



50 AK0004 Stabstangenlagerwippe



50 AK0029 Hauptrotorwelle



50 AK0031 Hauptzahnrad



50 AK0032 Heckriemenrad



50 AK0060 Heckrohr

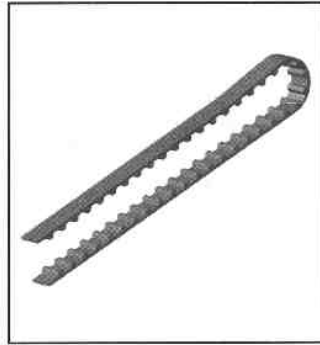

50 AK0089 Zahnriemen



50 AV0038 Lüfterrad



50 AV0052 Riemenrolle montiert



50 NO.9219 Dämpfer



50 PV0002 Winkelhebel Set



50 PV0004 Mischhebel

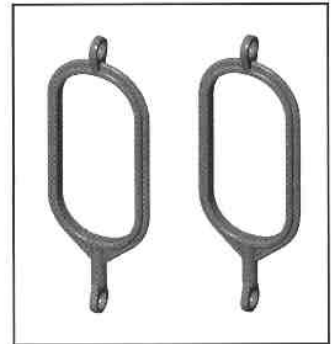

50 PV0005 Mischhebelgestänge

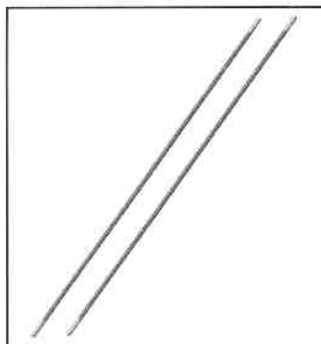

50 PV0008 Paddelstange



50 PV0011 Pitchkompensator



50 PV0012 Pitchbrücke



50 PV0013 Nick Control Arm



50 PV0014 Nick Control Hebel



50 PV0015 Roll Winkelhebel



50 PV0016 Heckrotorwinkelhebel



50 PV0017 Steuerbrücke Set



50 PV0018 Hauptrotorwellensicherungring



50 PV0019 Freilauf



50 PV0020 Freilaufwelle

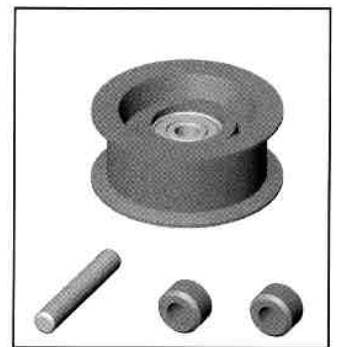

50 PV0021 Riemenrollen Mont.



50 PV0022 Motorträger

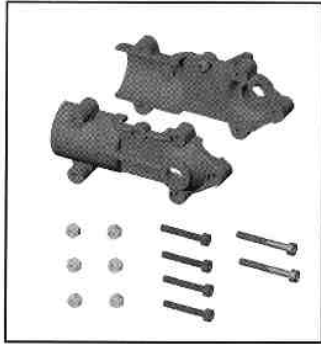

50 PV0027 Heckrotorgehäuse



50 PV0029 Heckrotorriemenrad



50 PV0030 Heckrotorwelle

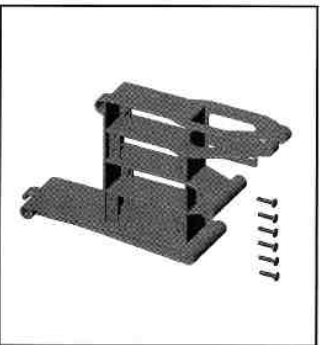

50 PV0033 Servohalter

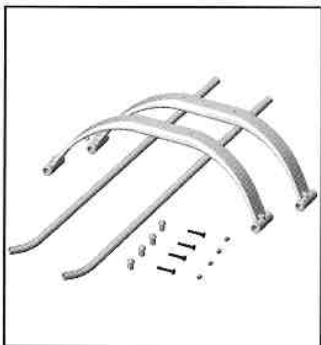

50 PV0035 Kufen Set



50 PV0036 Paddel



50 PV0037 Heckrotorblatt

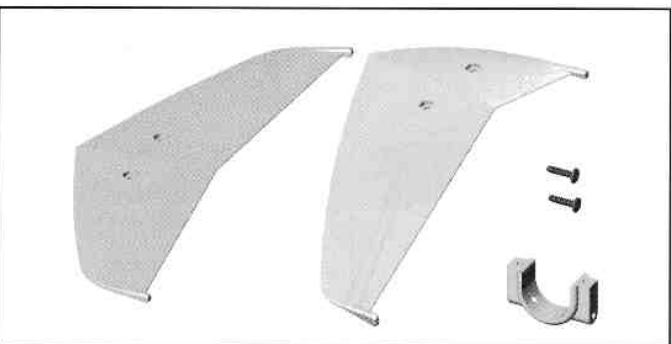

50 PV0038 Leitwerk Set

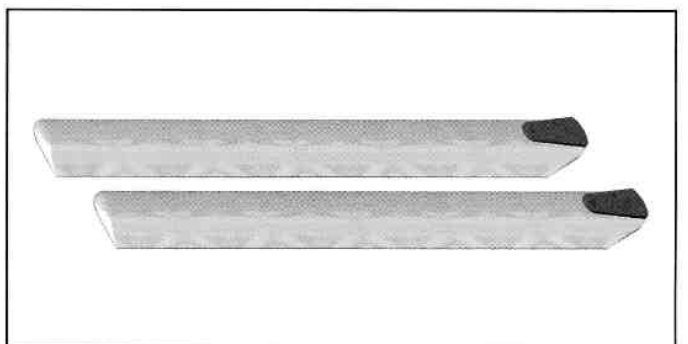

50 PV0039 Hauptrotorblatt



50 PV0040 Doppelkugelkopf



50 PV0041 Kugelkopf

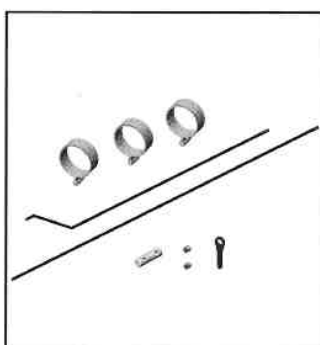

50 PV0043 Heckrotoransteuerung

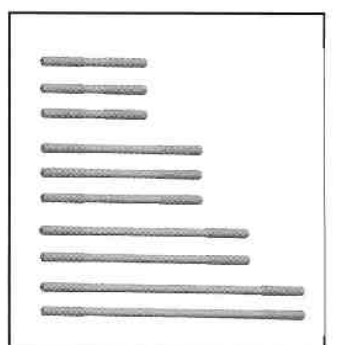

50 PV0044 Gestänge



50 PV0048 Stabstangenwippen Kugellager



50 PV0049 Stabiwippe/ Heckblatth. Kugellager



50 PV0051 Winkelhebelkugellager



50 PV0052 Steuerbrücken Kugellager



50 PV0053 Rotorblattschrauben

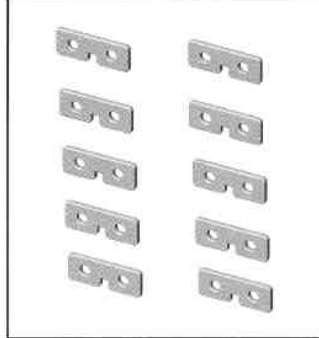

50 PV0054 Servobefestigungsplatte



50 PV0056 Chassisverbinder (L)

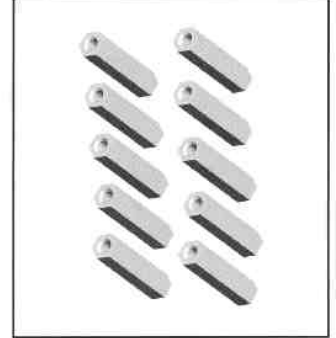

50 PV0057 Chassisverbinder (S)

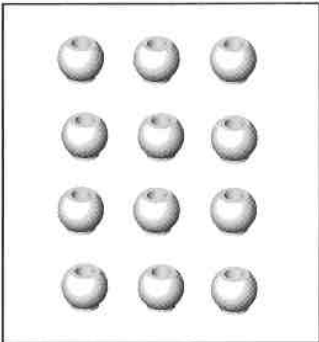

50 PV0058 Kugel

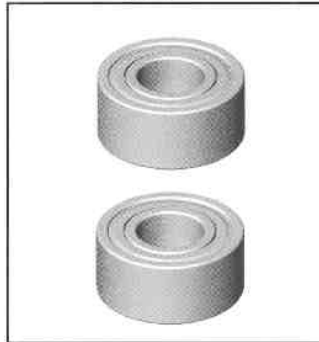

50 PV0059 Tail Shaft/Clutch Bell

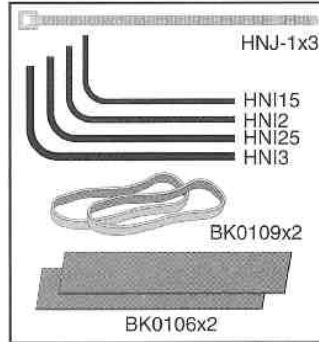

50 PV0060 Installations Set

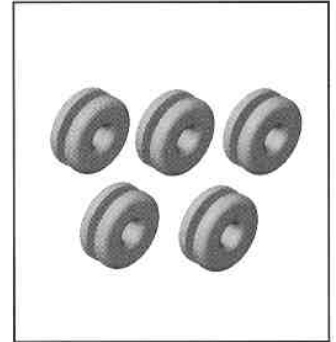

50 PV0062 Gummidurchführung



50 PV0063 Buchsen Set(für 4831/4832)



50 PV0064 Buchsen Set(für 4831/4832)

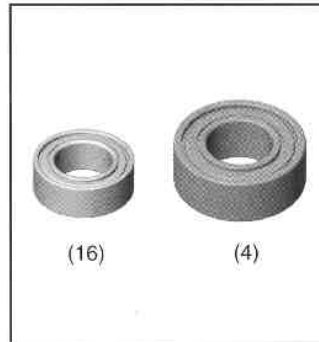

50 PV0091 Kugellagernachrüst-satz

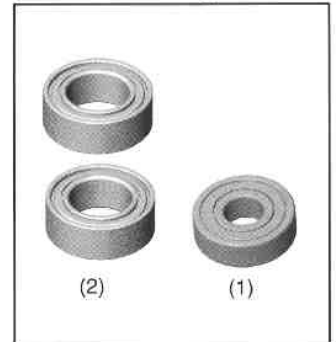

50 PV0093 Hauptrotorwellenlager



50 PV0148 Heckrotorblatthalter



50 PV0151 Heckrotormabe



50 PV0200 Heckrotorkugellager



50 PV0203 Starterwellenkugellager



50 PV267 Loctite #242



50 PV268 Loctite #262

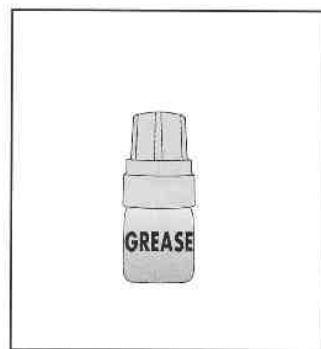

50 PV0269 Kugellagerfett



50 PV0270 Kunststoffgetriebefett



50 PV0279 Heckrohrgestängeführung

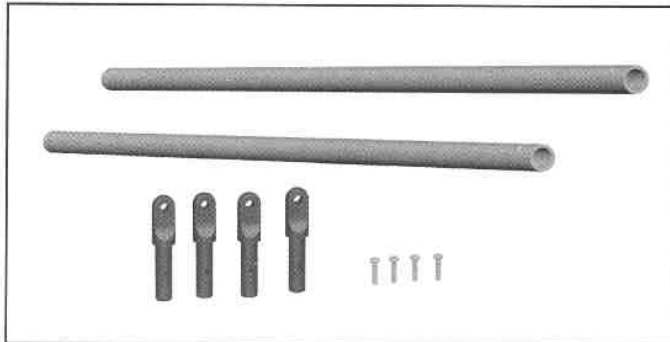

50 PV0328 Heckstreben Set



50 PV0353 Blatthalter Set



50 PV0354 Rotorkopfzentralstück



50 PV0355 Blattlagerwelle



50 PV0356 Dämpfer



50 PV0357 Taumelscheibe



50 PV0358 Kupplungsglocke



50 PV0359 Kupplung



50 PV0360 Starterwelle

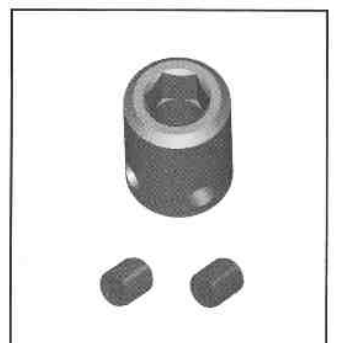

50 PV0361 Starteradapter

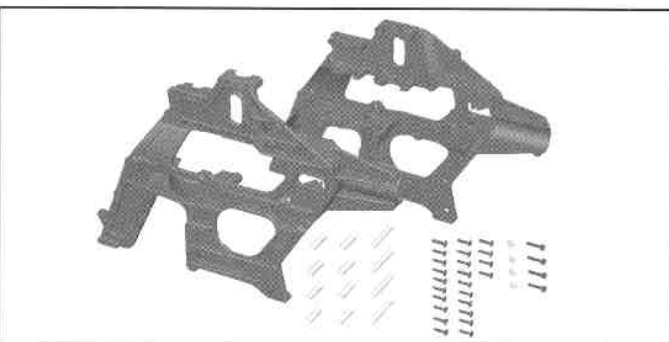

50 PV0362 Chassis Set



50 PV0363 Tank



50 PV0365 Axiallager

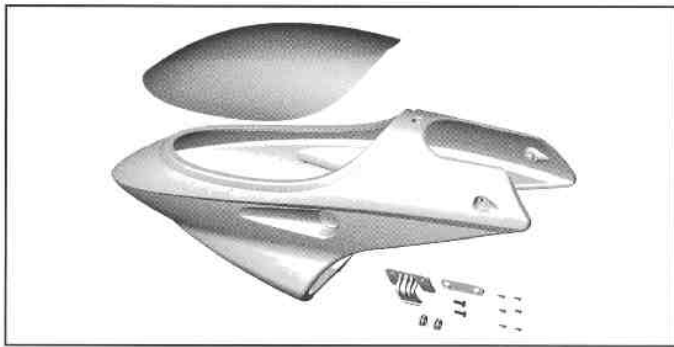

50 PV0364 Haube

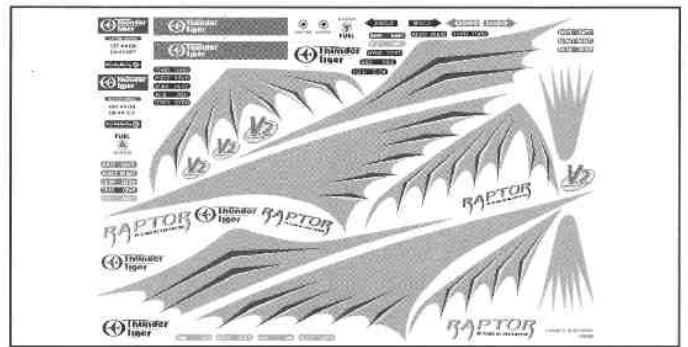

50 PV0366 Dekorbogen



50 PV0367 Ritzel (9T)

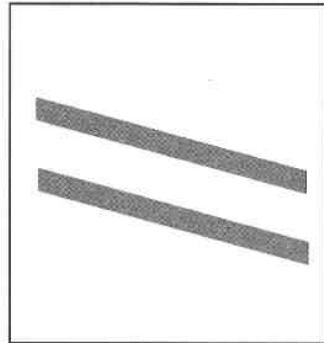

50 PV0368 Kupplungsbelag

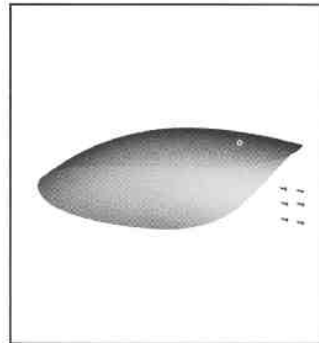

50 PV0369 Fenster

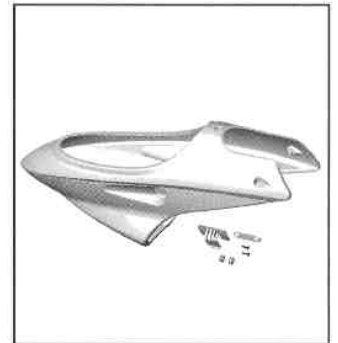

50 PV0370 Haube



50 PV0372 Druckscheibe



50 PV0373 Kupplungsglockenlager



50 PV0374 BlatthalterKugellager

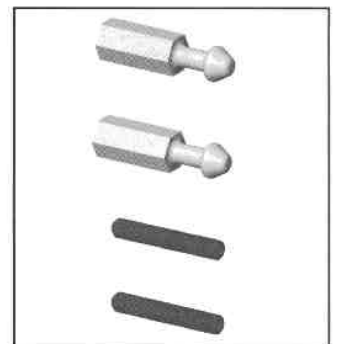

50 PV0375 Haubenhalter Set

	HMF2-6N M2X6 HMF2-8N M2X8
	HMJ2-10N M2X10 HMJ2-14N M2X14 HMJ2-6B M2X6 HMJ3-22B M3X22
	HSE2-10B M2X10 HSE2612N M2.6X12 HSE3-12B M3X12 HSE3-18B M3X18
	HSE3-5B M3X5

50 PV0088 Schraubenbeutel

	HMC3-10B M3X10 HMC3-12B M3X12 HMC3-14B M3X14 HMC3-20B M3X20 HMC3-25B M3X0.5L25 HMC3-32B M3X0.5XL32 HMC3-8B M3X8 BK0616 M3x20
	HME3-10B M3X10 HME3-18B M3X18 HME3-5B M4X5

50 PV0089 Schraubenbeutel

Es können nur die Best.-Nr. 50PV..... bestellt werden, nicht die Teile-Nr. !

Best.-Nr.	Bezeichnung	Teile-Nr.	Teilebezeichnung	Menge	Montage Schritt
50 AK0004	Stabstangenlagerwippe	50 BK0004	Stabstangenlagerwippe	1	11
50 AK0029	Hauptrotorwelle	50 BK0029	Hauptrotorwelle	1	7
50 AK0031	Hauptzahnrad	50 BK0031	Hauptzahnrad	1	4
50 AK0032	Heckriemenrad	50 BK0032	Heckriemenrad	1	4
50 AK0060	Heckrohr	50 BK0060	Heckrohr	1	14
50 AK0089	Zahnriemen	50 BK0089	Zahnriemen	1	14
50 AV0038	Lüfterrad	50 BV0038	Lüfterrad	1	9
50 AV0052	Riemenrolle montiert	50 BV0052	Riemenrolle	1	9
50 No.9219	Dämpfer	50 BN219	Dämpfer	1	10
50 PV0002	Winkelhebel Set	50 BK0002	Winkelhebel	2	11
		50 BK0005	Winkelhebelbuchse	2	11
		50 HME4-5B	Madenschraube (M4x5)	2	11
		50 HMJ2-10N	Selbstschneidschraube (M2x10)	2	11
		50 BK0075	Kugel	2	11
50 PV0004	Mischhebel	50 BK0006	Mischhebel	2	11
		50 BK0076	Buchse (d3xD4xL10)	2	11
		50 BK0075	Kugel	4	11
		50 BK0088	Paßscheibe	2	11
		50 HMJ2-10N	Selbstschneidschraube (M2x10)	4	11
		50 HMC3-14B	Inbusschraube (M3x14)	2	11
50 PV0005	Mischhebelgestänge	50 BK0007	Mischhebelgestänge	2	11
50 PV0008	Paddelstange	50 BK0010	Paddelstange	2	11
50 PV0011	Pitchkompensator	50 BK0014	Pitchkompensatormittelteil	1	5
		50 BK0015	Pitchkompensatorarm	2	5
		50 BK0016	Y-Verbinder	2	5
		50 BK0079	Pin	2	5
		50 BK0077	Buchse (d3xD4xL6)	2	5
		50 HMC3-10B	Inbusschraube (M3x10)	2	5
		50 HMJ2-10N	Selbstschneidschraube (M2x10)	2	5
		50 BK0075	Kugel	2	5
50 PV0012	Pitchbrücke	50 BK0017	Pitchbrücke	1	6
		50 BK0078	Buchse (d3xD4xL4)	2	6
		50 HMJ3-22B	Selbstschneidschraube (M3x22)	1	6
		50 HSE3-12B	Selbstschneidschraube (M3x12)	1	6
		50 BK0075	Kugel	1	6
		50 HMJ2-10N	Selbstschneidschraube (M2x10)	1	6
50 PV0013	Nick Control Arm	50 BK0018	Nick Control Arm	1	6
		50 BK0019	Nick Arm parallel Hebel	1	6
		50 BK0020	Nick Control Arm Welle	1	6
		50 BK0023	Nick Control Verbinder	2	6
		50 BK0084	Pin (D2xL23)	2	6
		50 BK0075	Kugel	1	6
		50 HMJ2-10N	Selbstschneidschraube (M2x10)	1	6
		50 HSE3-18B	Selbstschneidschraube (M3x18)	2	6
50 PV0014	Nick Control Hebel	50 BK0021	Nick Control Hebel	1	6
		50 BK0076	Buchse (d3xD4xL10)	1	6
		50 HMJ2-14N	Selbstschneidschraube (M2x14)	1	6
		50 BK0088	Paßscheibe	1	6
		50 BK0075	Kugel	2	6
50 PV0015	Roll Winkelhebel	50 BK0022	Roll Winkelhebel	2	6
		50 BK0076	Buchse (d3xD4xL10)	2	6
		50 BK0075	Kugel	4	6
		50 HMJ2-10N	Selbstschneidschraube (M2x10)	4	6

Es können nur die Best.-Nr. 50PV..... bestellt werden, nicht die Teile-Nr. !

Best.-Nr.	Bezeichnung	Teile-Nr.	Teilebezeichnung	Menge	Montage Schritt
		50 HSE3-18B	Selbstschneidschraube (M3x18)	2	6
50 PV0016	Heckrotorwinkelhebel	50 BK0024	Heckrotorwinkelhebel	1	13
		50 BK0076	Buchse (d3xD4xL10)	1	13
		50 BK0075	Kugel	1	13
		50 BK0088	Paßscheibe	1	13
		50 HMJ2-8N	Selbstschneidschraube (M2x10)	1	13
		50 HSE3-18B	Selbstschneidschraube (M2x10)	1	13
50 PV0017	Steuerbrücke Set	50 BK0025	Steuerbrücke	1	13
		50 BK0026	Steuerbrückenverbinder	2	13
		50 BK0027	Steuerring	1	13
		50 BK0028	Steuerhülse	1	13
		50 BK0075	Kugel	1	13
		50 BK0082	Buchse (d2xD3xL4)	2	13
		50 BK0083	Pin (D2xL9)	2	13
		50 HMF2-8N	Schraube (M2x8)	1	13
		50 HSE2-10B	Selbstschneidschraube (M2x10)	2	13
50 PV0018	Hauptrotorwellensicherungsring	50 BK0030	Hauptrotorwellensicherungsring	1	7
		50 HME4-5B	Madenschraube (M4x5)	2	7
50 PV0019	Freilauf	50 BV0033	Freilauf	1	4
		50 HMC3-12B	Inbusschraube (M3x12)	4	4
50 PV0020	Freilaufwelle	50 BK0034	Freilaufwelle	1	4
		50 HMQ14	Sicherungsring	2	4
		50 HMC3-20B	Inbusschraube (M3x20)	1	7
		50 HMM3Z	Stopmutter M3	1	7
50 PV0021	Riemenrollen Mont.	50 BV0035	Riemenrolle	1	3
		50 BK0036	Riemenrand	2	3
		50 BK0081	Pin	1	3
50 PV0022	Motorträger	50 BK0037	Motorträger	1	10
		50 HMC3-14B	Inbusschraube (M3x14)	8	10
		50 BK0087	Unterlegscheibe	4	10
50 PV0027	Heckrotorgehäuse	50 BK0046	Heckrotorgehäuse (L)	1	13
		50 BK0047	Heckrotorgehäuse (R)	1	14
		50 HMC3-20B	Inbusschraube (M3x20)	4	14
		50 HMC3-25B	Inbusschraube (M3x25)	2	14
		50 HMM3Z	Stopmutter M3	6	14
50 PV0029	Heckrotorriemenrad Set	50 BK0050	Heckrotorriemenrad	1	13
		50 BK0051	Riemenradflansch	1	13
		50 BK0414	Sicherungsstift D2xL12	1	13
		50 HME3-4B	Madenschraube (M3x4)		
50 PV0030	Heckrotorwelle	50 BK0053	Heckrotorwelle	1	13
		50 BK0414	Sicherungsstift D2xL12	1	13
		50 HME3-4B	Madenschraube (M3x4)		
50 PV0033	Servohalter	50 BK0057	Servohalter	1	3
		50 HMJ3-12B	Selbstschneidschraube (M3x12)	6	3
50 PV0035	Kufen Set	50 BK0064	Kufe	2	8
		50 BK0065	Kufenendkappen	4	8
		50 BK0066	Kufenbügel	2	8
		50 HMJ3-18B	Selbstschneidschraube (M3x18)	4	8
		50 HME4-5B	Madenschraube (M4x5)	4	8
50 PV0036	Paddel	50 BK0067	Paddel	2	11
		50 HME3-10B	Madenschraube (M3x10)	2	11
50 PV0037	Heckrotorblatt	50 BK0068	Heckrotorblatt	2	15
50 PV0038	Leitwerk Set	50 BK0069	Höhenleitwerk	1	14

Es können nur die Best.-Nr. 50PV..... bestellt werden, nicht die Teile-Nr. !

Best.-Nr.	Bezeichnung	Teile-Nr.	Teilebezeichnung	Menge	Montage Schritt
		50 BK0070	Höhenleitwerksschelle	1	14
		50 BK0071	Seitenleitwerk	1	14
		50 HSE3-12B	Selbstschneidschraube (M3x12)	2	14
50 PV0039	Hauptrotorblatt	50 BV0072	Hauptrotorblatt	2	18
50 PV0040	Doppelkugelkopf	50 BV0085	Doppelkugelkopf	2	11
50 PV0041	Kugelkopf	50 BK0086	Kugelkopf	12	6
50 PV0043	Heckrotoransteuerung	50 BK0091	Gestängeführung	3	14
		50 BK0100-1	Gestänge	1	16
		50 BK0100-2	Gestänge	1	16
		50 BK0086	Kugelkopf	2	14
		50 BK0105	Steuergestängeverbinder	1	16
		50 HME4-5B	Madenschraube (M4x5)	2	16
50 PV0044	Gestänge	50 BK0092	Gestänge (L=30)	3	17
		50 BK0093	Gestänge (L=45)	3	16
		50 BK0094	Gestänge (L=60)	2	16
		50 BK0095	Gestänge (L=76)	2	12
50 PV0048	Stabistangenwippe	50 HVM840ZZ	d4xD8xW3 Kugellager	2	6;11
50 PV0049	Stabiwippe/Heckblatth.	50 HVM830ZZ	d3xD8xW4 Kugellager	2	11;13
50 PV0051	Winkelhebelkugellager	50 HVM740ZZ	d4xD7xW2.5 Kugellager	4	6;13
50 PV0052	Steuerbrücke	50 HVM1060	d6xD10xW3 Kugellager	2	13
50 PV0053	Rotorblattschrauben	50 HMC4-27B	Inbusschraube (M4x27)	2	18
		50 HMM4Z	Stopmutter M4	2	18
50 PV0054	Servobefestigungsplatte	50 BK0104	Servobefestigungsplatte	10	
50 PV0056	Chassisverbinder (L)	50 BK0058	Chassisverbinder (L)	5	
50 PV0057	Chassisverbinder (S)	50 BK0059	Chassisverbinder (S)	10	
50 PV0058	Kugel	50 BK0075	Kugel	12	
50 PV0059	Tail Shaft/Clutch Bell Brg.	50 HVM1150	d5xD11xW Kugellager	2	2;13
50 PV0060	Installations Set	50 BE1052	Antennenrohr	1	
		50 BK0106	Doppelseitiges Klebeband	2	
		50 BK0109	Gummiringe 5x320xT1	2	
		50 HN115	Inbusschlüssel 1.5m/m	1	
		50 HN12	Inbusschlüssel 2m/m	1	
		50 HN125	Inbusschlüssel 2.5m/m	1	
		50 HN13	Inbusschlüssel 3m/m	1	
		50 HNJ-1	Kabelbinder 2.5x100	3	
50 PV0062	Gummidurchführung	50 BK0102	Gummidurchführung	5	20
50 PV0063	Buchsen Set(für 4831/4832)	50 BK0108	Buchse (d4xD8xW2.5)	2	6;13
50 PV0064	Buchsen Set(für 4831/4832)	50 BK0107	Buchse (d4xD7xW3)	4	6;11
50 PV0088	Schraubenbeutel	50 HMF2-6N	Schraube (M2x6)	6	
		50 HMF2-8N	Schraube (M2x8)	6	
		50 HMJ2-14N	Selbstschneidschraube (M2x14)	6	
		50 HMJ2-6B	Selbstschneidschraube (M2x6)	6	
		50 HMJ3-22B	Selbstschneidschraube (M3x22)	6	
		50 HSE2-10B	Selbstschneidschraube (M2x10)	6	
		50 HSE3-12B	Selbstschneidschraube (M3x12)	6	
		50 HSE3-18B	Selbstschneidschraube (M3x18)	6	
		50 HSE3-5B	Selbstschneidschraube (M3x5)	6	
		50 HMJ2-10N	Selbstschneidschraube (M2x10)	6	
		50 HSE2612N	Selbstschneidschraube (M2.6x12)	6	
50 PV0089	Schraubenbeutel	50 BK0616	Inbusschraube (M3x20)	2	
		50 HMC3-10B	Inbusschraube (M3x10)	6	
		50 HMC3-12B	Inbusschraube (M3x12)	6	

Es können nur die Best.-Nr. 50PV..... bestellt werden, nicht die Teile-Nr. !

Best.-Nr.	Bezeichnung	Teile-Nr.	Teilebezeichnung	Menge	Montage Schritt
		50 HMC3-14B	Inbusschraube (M3x14)	6	
		50 HMC3-20B	Inbusschraube (M3x20)	6	
		50 HMC3-25B	Inbusschraube (M3x25)	6	
		50 HMC3-32B	Inbusschraube (M3x32)	6	
		50 HMC3-8B	Inbusschraube (M3x8)	6	
		50 HME3-10B	Madenschraube (M3x10)	6	
		50 HME3-18B	Madenschraube (M3x18)	6	
		50 HME4-5B	Madenschraube (M4x5)	6	
50 PV0091	Kugellagernachrüstatz	50 HMV740ZZ	d4xD7xW2.5	16	
		50 HMV840ZZ	d4xD8xW3	4	
50 PV0093	Hauptrotorwellenlager	50 HMV1680	d8xD16xW5	1	
		50 HMV6800	d10xD19xW5	2	
50 PV0148	Heckrotorblatthalter	50 BK0302-1	Heckrotorblatthalter (A)	2	13
		50 BK0303-1	Heckrotorblatthalter (B)	2	13
		50 HMC3-14B	Inbusschraube (M3x14)	2	15
		50 HMC2610B	Inbusschraube (M2.6x10)	4	13
		50 HMM26B	Stopmutter M2.6	2	13
		50 HHM3B	Stopmutter M3	2	15
50 PV0151	Heckrotornabe	50 BK0307	Heckrotornabe	1	13
		50 HME3-18B	Madenschraube (M3x18)	2	13
		50 HMM3B	Stopmutter M3	2	13
50 PV0200	Heckrotornabenkugellager	50 HMV1050	d5xD10x5	4	13
50 PV0203	Starterwellenkugellager	50 HMV696Z	d6xD15x5	2	6
50 PV267	Loctite #242				
50 PV268	Loctite #262				
50 PV0269	Kugellagerfett				
50 PV0270	Kunststoffgetriebefett				
50 PV0279	Heckrohrgestängeführung	50 BK0091	Gestängeführung	3	14
50 PV0328	Heckstreben Set	50 BK0540	Heckstreben	2	14
		50 HSE3-12B	Selbstschneidschraube (M3x12)	4	14
		50 HMJ2-8N	Selbstschneidschraube (M2x8)	4	14
		50 BK0447	Heckstrebenenden	4	14
50 PV0353	Blatthalter Set	50 BK0596	Blatthalter	2	11
		50 HMJ2-10N	Selbstschneidschraube (M2x10)	2	11
		50 BK0075	Kugel	2	11
50 PV0354	Rotorkopfzentralstück	50 BK0595	Rotorkopfzentralstück	1	11
		50 BK0587	Hauptrotornabe	1	11
		50 HMM3Z	Stopmutter (M3)	1	12
		50 BK0616	Inbusschraube (M3x20)	1	12
50 PV0355	Blattlagerwelle	50 BK0583	Blattlagerwelle	1	11
		50 BK0581	Schlagbuchse	2	11
		50 BK0435	Scheibe d4xD11x1.7	2	11
		50 HMC4-8B	Inbusschraube (M4x8)	2	11
50 PV0356	Dämpfer	50 BK0582	Dämpfer	2	11
50 PV0357	Taumelscheibe	50 BV0601	Taumelscheibe	1	7
50 PV0358	Kupplungsglocke	50 BV0591	Kupplungsglockenset	1	2
50 PV0359	Kupplung	50 BV0589	Kupplungsset	1	9
		50 BK0170	Scheibe	1	9
		50 HMC3-10B	Inbusschraube (M3x10)	2	9
50 PV0360	Starterwelle	50 BK0592	Starterwelle	1	3
		50 HME4-5B	Madenschraube (M4x5)	2	3
		50 HMS5	Sicherungsscheibe	1	3
50 PV0361	Starteradapter	50 BK0594	Starteradapter	1	3

Es können nur die Best.-Nr. 50PV..... bestellt werden, nicht die Teile-Nr. !

Best.-Nr.	Bezeichnung	Teile-Nr.	Teilebezeichnung	Menge	Montage Schritt
		50 HME4-5B	Madenschraube (M4x5)	2	3
50 PV0362	Chassis Set	50 BK0599	Chassis links	1	3
		50 BK0600	Chassis rechts	1	3
		50 BK0058	Verbinder (L)	4	3
		50 BK0059	Verbinder (S)	8	3
		50 HSE3-12B	Selbstschneidschraube (M3x12)	24	3
		50 HMC3-20B	Inbusschraube (M3x20)	4	15
		50 HMM3Z	Stopmutter M3	4	15
50 PV0363	Tank	50 BV0605	Tankset	1	1
50 PV0364	Haube	50 BK0611	Haube	1	19
		50 BK0098	Haubenbefestigung A	1	19
		50 BK0099	Haubenbefestigung B	1	19
		50 BK0102	Gummidurchführung	2	19
		50 HSE3-12B	Selbstschneidschraube (M3x12)	2	19
		50 BK0612	Fenster	1	19
50 PV0365	Axiallager	50 HMX0612	Axiallager	2	11
50 PV0366	Dekorbogen	50 JV0093	Dekorbogen	1	19
50 PV0367	Ritzel (9T)	50 BK0593	Ritzel	1	2
50 PV0368	Kupplungsbelag	50 BK0590	Kupplungsbelag	2	2
50 PV0369	Fenster	50 BK0612	Fenster	1	19
		50 HMJ2-6B	Selbstschneidschraube (M2x6)	6	19
50 PV0370	Haube	50 BK0098	Haubenbefestigung (A)	1	19
		50 BK0099	Haubenbefestigung (B)	1	19
		50 BK0611	Haube	1	19
		50 BK0102	Gummidurchführung	2	19
		50 HSE3-12B	Selbstschneidschraube (M3x12)	2	19
50 PV0372	Druckscheibe	50 BK0584	Druckscheibe	2	11
50 PV0373	Kupplungsglockenlager	50 HMV1260Y	d6xD12xw4	2	6
50 PV0374	BlatthalterKugellager	50 HMV1360Z	d6xD13xw5	2	11
50 PV0375	Haubenthalter Set	50 BK0626	Haubenthalter	2	12
		50 HME3-18B	Madenschraube M3x18	2	12

HELICOPTER ACCESSORIES



50No.3800 Blatthalter

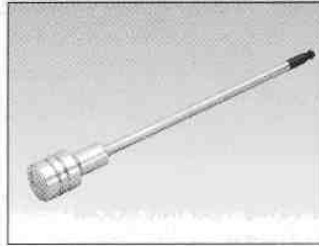

50No.3801 6mm Starteradapter

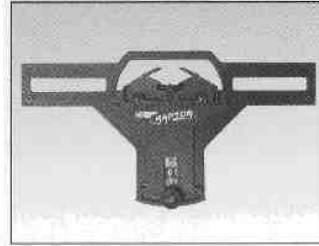

50No.3802 Pitchlehre

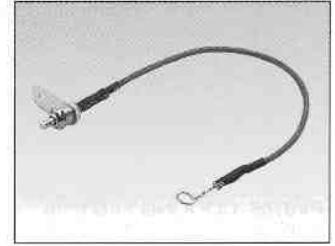

50No.3803 Glühkerzenadapter



50No.2000 On Board Drehzahlmesser

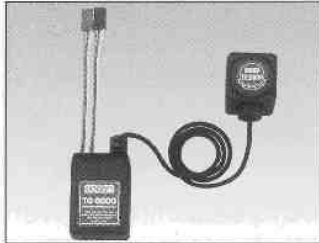

50No.8000 TG-8000 Piezo Kreisel

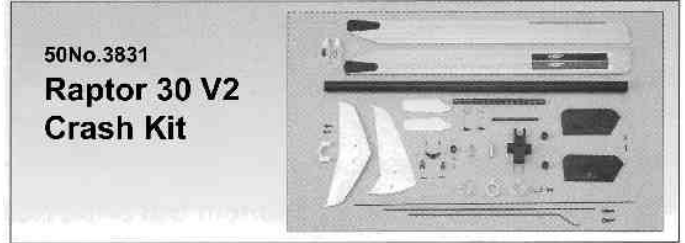

50No.3831
Raptor 30 V2
Crash Kit



50No.3832
Raptor 30 V2
Umrüstsatz

von Version 1
auf Version 2



RAPTOR 30 V2 OPTIONAL PARTS

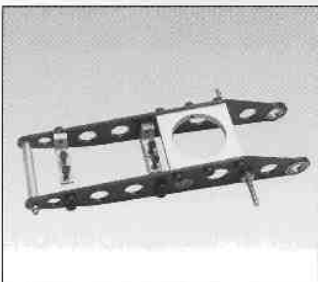

50PV0068 Alu/CFK Pitchbrücke



50PV0092 Alu Taumelscheibe

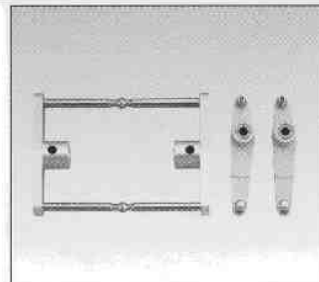

50PV0095 Alu Stabilisator/
Mischhebel



50PV0096 Alu Pitchkompensator

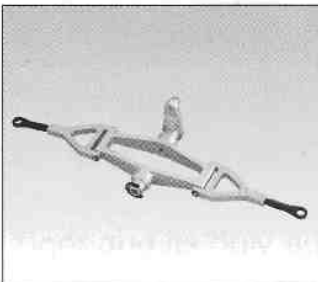

50PV0097 Alu Nickansteuerung

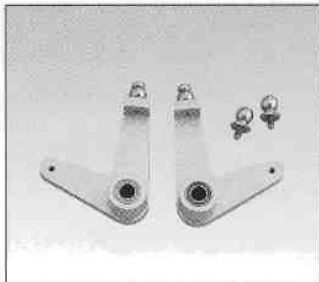

50PV0098 Alu Rollwinkelhebel

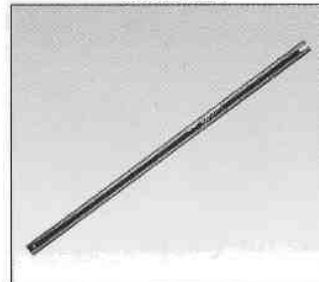

50PV0099 Carbon Heckrohr

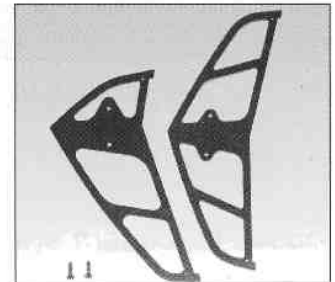

50PV0100 Carbon Leitwerke

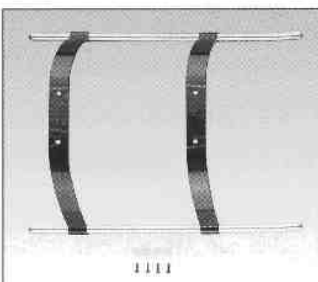

50PV0101 Carbon Kufengestell

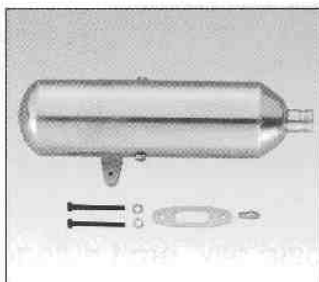

50PV0102 Tuningdämpfer

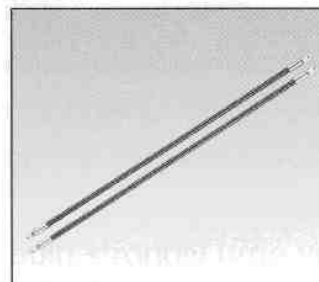

50PV0103 Carbon Heckstreben

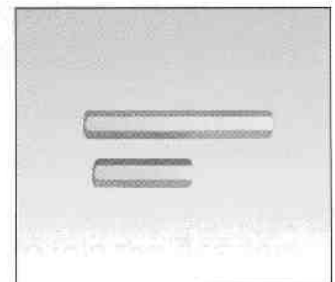

50PV0104 Alu Chassisverbinder



50PV0105 Alu Lüfter (36ccm)
50PV0106 Alu Lüfter (46ccm)

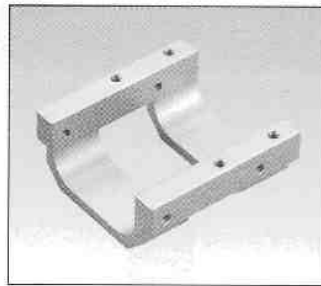

50PV0107 Motorträger (46ccm)

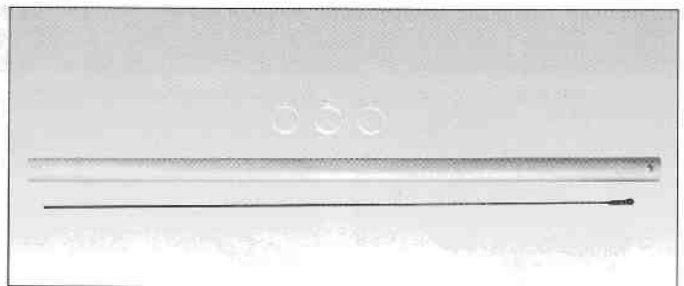

50PV0108 Raptor 50 Heckrohr Set

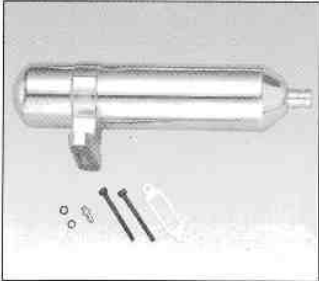

50PV0109 Tuningdämpfer
(.46-50-Motoren)

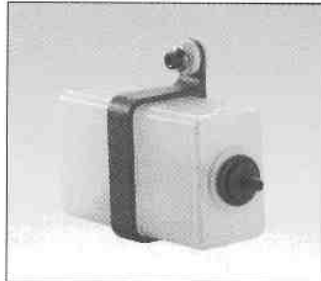

50PV0311 Zusatztank

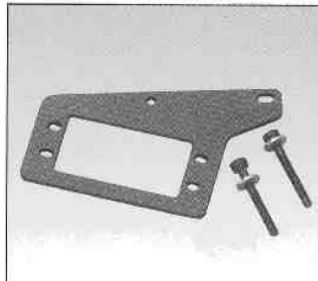

50PV0321 Heckrotorservobefestigung, hinten

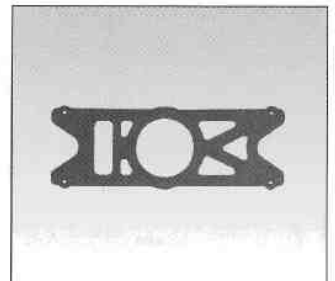

50PV0326 CFK Grundplatte

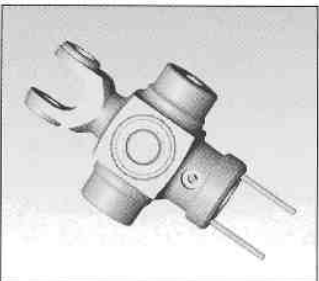

50PV0338 Alu Rotorkopfzentralstück für R 30 V2



50PV0339 Alu Blatthalter für R 30 V2

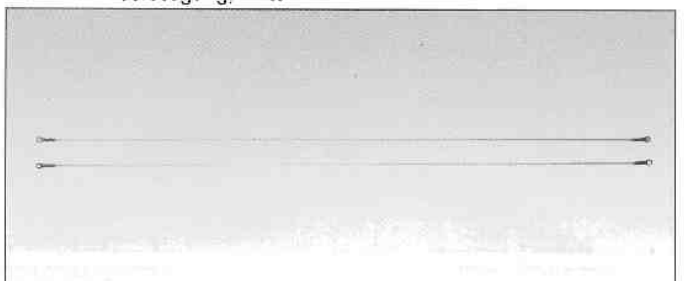

50PV0345 R 30 Servogestänge, hinten für 50PV0321
50PV0346 R 50 Servogestänge, hinten für 50PV0321

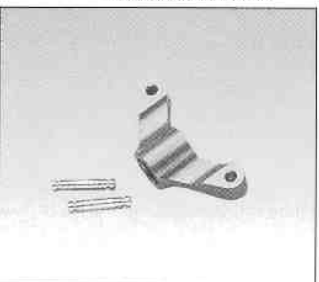

50PV0341 Alu Steuerbrücke

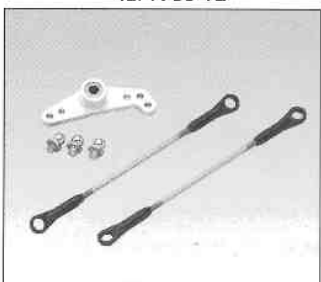

50PV0349 Push/Pull Set für Nicksteuerung



50PV0379 Heckriemenrad bei Autorotation mittedrehender Rotor

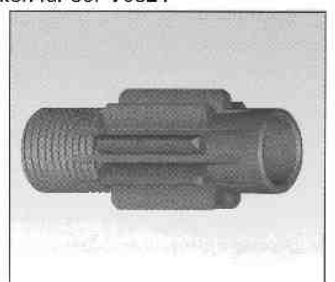

50PV0380 Ritzel (10T)



50PV0381 70 Dämpfer, für extremes 3D V2 fliegen



50PV0381 80 Dämpfer, für noch extremeres 3D V2 fliegen

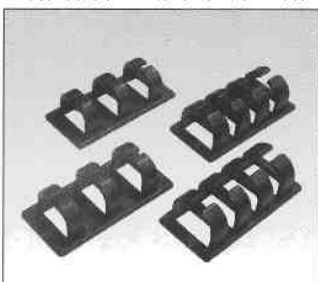

50PV0384 Kabelhalter